

Article number: 03505090

Description: Fluro Rod end GE 90FO

Measures

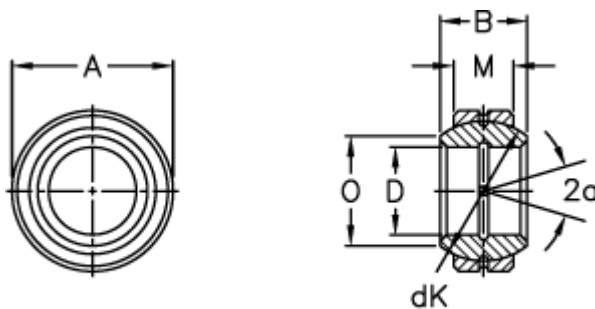

Str. 6–12 uden smørerille

A = 150 0 -0,018

B = 85

D = 90 0 -0,020

dK = 130

Dynamic load C (kN) = 610

M = 55

O = 98.3

Static load C0 (kN) = 3050

Tilt angle = 15

Weight = 5400